

MaxiForce™ Collapsible Bollard

Standard Body, Wrench Operated, Standard Style 1 Head, Universal Base

AHJ approved in many cities / counties / campuses for use in fire lanes per International Fire Code (IFC) 503

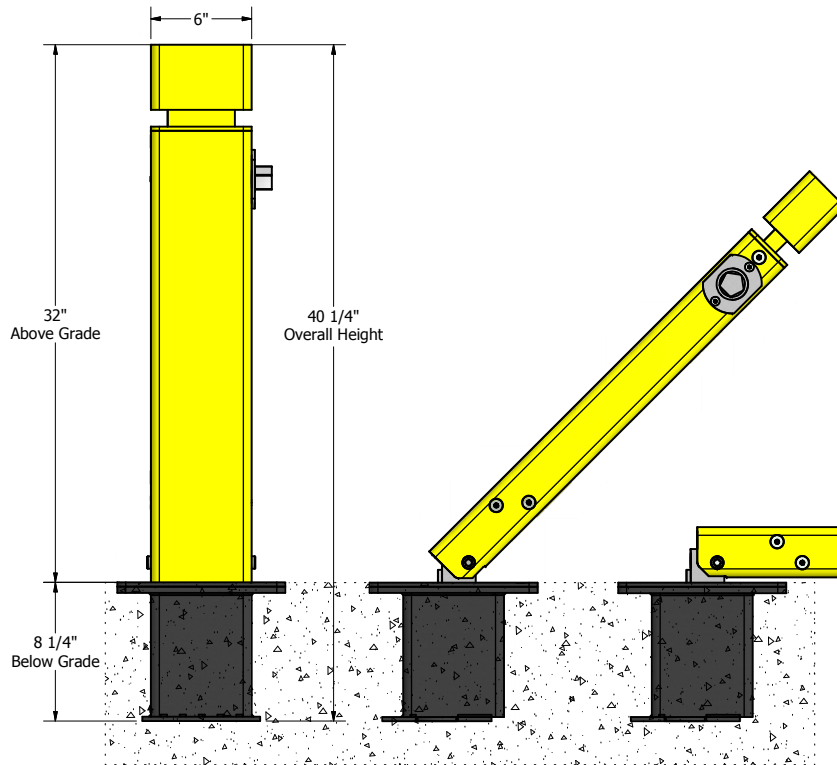

Patented fire hydrant wrench operation works with any standard fire hydrant wrench by turning the nut 1/4 turn to unlock and lower the bollard. (1-3/8" nut standard)
*Free standard hydrant wrench included with each order

Patented break-away design allows instant emergency access without a key. This unit can be pushed over with the bumper of a vehicle.

Flush surface when bollard is removed. Leaves no tripping hazard and won't catch snow plows or other maintenance equipment.

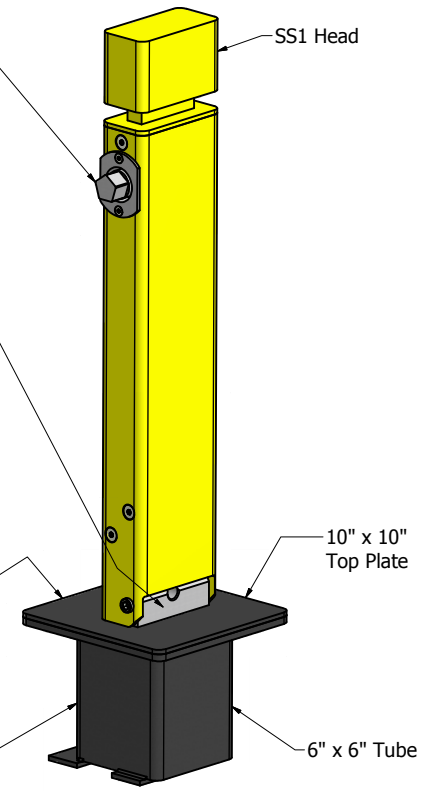

- Low Maintenance / Durable steel construction
- One year warranty / Protected by \$1,000,000 in liability insurance
- No complex assembly required in the field
- Custom sizes, options, colors and finishes available upon request
- Finish options available (add code to the end of the model number)
 - Powder coated (PC)
 - Powder coated with DRYZINC primer (PCZ)
 - Hot dip galvanized (G)
 - Hot dip galvanized & powder coated (GPC)
- Reflective tape available upon request

Bollard Assy. Weight 58 lbs	Base Weight 28 lbs
Drawing Rev. 1	Created 11/2/2009

PROPRIETARY AND CONFIDENTIAL

THIS DRAWING CONTAINS PROPRIETARY INFORMATION OF BLUE EMBER TECHNOLOGIES, LLC. ANY USE OF THIS DRAWING OR THE INFORMATION CONTAINED HEREIN FOR OTHER THAN THE PURPOSE FOR WHICH THIS DRAWING IS FURNISHED IS FORBIDDEN.

	MaxiForce™ Traffic Control Bollards		
	7560 Main Street Sykesville, MD 21784 410-552-9888 (phone) - 410-552-9939 (fax) www.maxiforcebollards.com - sales@maxiforcebollards.com		
Model	MCSW-SS1-U		
Size	File Name	MCSW-SS1-U	
C	Scale	NA	DO NOT SCALE DRAWING
		Sheet	1 Of 1